

GARDEN HOUSE

EN DE CZ SK HU PL

PAH 357

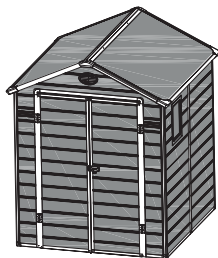

۲۷



Thank you for purchasing our product.

Before using this unit, please read this manual.

Assembly instructions:

Prior to the assembly please read all instructions and information carefully.

Check whether you have all parts which are necessary for the assembly.

The plastic shed has to be anchored to its base in order to prevent damage. The base is not included in the delivery and it has to be built separately.

Please mind your own safety.

1. Assemble the shed in dry, calm conditions. Do not assemble in windy conditions.
2. 2-4 persons are required for the assembly of this plastic shed.
3. Use protective clothing, gloves and goggles when assembling the shed.
4. During the assembly no children or pets should be present in the working area.

Care and maintenance:

1. Keep the doors closed and locked when the shed is not in use to prevent wind damage.
2. Clean the house using cloth and water.
3. Always remove fallen leaves from the roof as soon as possible to prevent them staining the roof. In case of snowfall remove the snow from the roof regularly. Large amounts of snow on the roof can damage the shed.
4. The house is not designed for living but only for storage purposes. Do not store hot items, such as recently used grills, blowtorches and volatile chemicals in the shed.

The English version of the manual is an exact translation of the original manufacturer's instructions. Images used in this manual are for illustrational purposes only and may differ from the actual product.



Vielen Dank für den Kauf unseres Produktes.

Bevor Sie dieses Gerät verwenden, lesen Sie diese Anleitung.

Montageanleitung:

Bevor Sie mit der Montage beginnen, lesen Sie sorgfältig alle Anweisungen und Informationen durch.

Überprüfen Sie, ob Ihnen alle notwendigen Teile für den Bau des Gartenhauses zur Verfügung stehen.

Das Gartenhaus muss ordnungsgemäß an der Grundplatte verankert werden, damit es bei starkem Wind nicht zur dessen Beschädigung oder Zerstörung kommt. Die Grundplatte ist nicht im Lieferumfang enthalten, diese muss getrennt gebaut werden.

Achten Sie auf Ihre Sicherheit.

1. Die Montage des Hauses ist an einem trockenen Ort und bei guten Wetterbedingungen durchzuführen.
2. Montieren Sie das Haus in 2-4 Personen.
3. Tragen Sie bei der Montage Schutzkleidung, Handschuhe und Schutzbrille.
4. Während der Montage sollten sich auf der Baustelle keine Kinder und Haustiere bewegen.

Pflege und Wartung:

1. Halten Sie die Tür geschlossen und verriegelt, um Beschädigungen durch Wind zu vermeiden.
2. Reinigen Sie das Haus mit einem Tuch und Wasser.
3. Entfernen Sie Laubblätter immer möglichst schnell, um Verfärbungen des Dachs zu vermeiden. Entfernen Sie den gefallenen Schnee regelmäßig vom Dach. Größere Schneemengen auf dem Dach können Schäden am Dach verursachen.
4. Das Haus ist nicht zum Wohnen, sondern zum Aufbewahren von Sachen vorgesehen. Im Gartenhaus dürfen keine heißen Gegenstände wie heiße Grills, UV-Lampen, flüchtige Chemikalien usw. gelagert werden.

Die deutsche Version der Anleitung ist eine genaue Übersetzung der Anleitung des Herstellers. Die in diesem Handbuch verwendeten Bilder dienen nur zur Illustration und können nicht genau das Produkt entsprechen.



Děkujeme za nákup našeho výrobku.

Před použitím si prosím přečtěte tento návod.

Montážní návod:

Dříve, než začnete s montáží, pečlivě si prostudujte všechny pokyny a informace.

Zkontrolujte, zda máte všechny potřebné díly pro stavbu domku.

Domek musí být řádně ukotven k základové desce, aby nedošlo při silném větru k jeho poškození nebo zničení. Základová deska není součástí balení, je nutné si ji vybudovat samostatně.

Dbejte na svoji bezpečnost.

1. Montáž domku provádějte na suchém místě a za dobrých povětrnostních podmínek.
2. Domek montujte ve 2-4 lidech.
3. Při montáži používejte ochranný oděv, rukavice a ochranné brýle.
4. V době montáže by se po staveništi neměly pohybovat děti a domácí zvířata.

Péče a údržba:

1. Dveře od domku nechávejte zavřené a zamčené, aby nedošlo k poškození vlivem větru.
2. Domek čistěte za pomoci hadru a vody.
3. Vždy odstraňte spadané listí ze střechy co nejdříve, aby nedošlo k zbarvení střechy. Ze střechy pravidelně odstraňujte napadaný sníh. Větší nános sněhu na střeše může způsobit poškození střechy.
4. Domek není určen pro bydlení, ale pro ukládání věcí. V zahradním domku neskladujte horké předměty, jako např. rozpálený gril, opalovací lampy, těkavé chemikálie apod.

Česká verze návodu je přesným překladem originálního návodu výrobce.

Fotografie použité v manuálu jsou pouze ilustrační a nemusí se přesně shodovat s výrobkem.



Ďakujeme za nákup nášho výrobku.

Pred použitím si prosím prečítajte tento návod.

Montážny návod:

Skôr, než začnete s montážou, starostlivo si preštudujte všetky pokyny a informácie.

Skontrolujte, či máte všetky potrebné diely pre stavbu domčeka.

Domček musí byť riadne ukotvený k základnej doske, aby nedošlo pri silnom vetre k jeho poškodeniu alebo zničeniu. Základná doska nie je súčasťou balenia, je nutné si ju vybudovať samostatne.

Dbajte na svoju bezpečnosť.

1. Montáž domčeku vykonávajte na suchom mieste a za dobrých poveternostných podmienok
2. Domček montujte v 2-4 ľuďoch.
3. Pri montáži používajte ochranný odev, rukavice a ochranné okuliare.
4. V čase montáže by sa po stavenisku nemali pohybovať deti a domáce zvieratá.

Starostlivosť a údržba:

1. Dvere od domčeku nechávajú zatvorené a zamknuté, aby nedošlo k poškodeniu vplyvom vetra.
2. Domček čistite s pomocou handry a vody.
3. Vždy odstráňte opadané listy zo strechy čo najskôr, aby nedošlo k sfarbeniu strechy. Zo strechy pravidelne odstraňujte napadajúci sneh. Väčšia nános snehu na streche môže spôsobiť poškodenie strechy.
4. Domček nie je určený pre bývanie, ale pre ukladanie vecí. V záhradnom domčeku neskladujte horúce predmety, ako napr. Rozpálený gril, opaľovacie lampy, prchavé chemikálie a pod.

Slovenská verzia návodu je presným prekladom originálneho návodu výrobcu.

Fotografie použité v návode sú len ilustračné a nemusia sa presne zhodovať s výrobkom.



Köszönjük, hogy megvásárolta termékünket.

Használat előtt kérjük olvassa el a használati útmutatót.

Összeszerelési útmutató

Az összeszerelés megkezdése előtt alaposan olvassa el az összes utasítást és információt.

Győződjön meg róla, hogy rendelkezésére áll minden szükséges alkatrész a kerti ház összeszereléséhez.

A házat megfelelően rögzíteni kell az alapszerkezethez, hogy az erős szél ne tegyen kárt benne. Az alapszerkezetet a csomagolás nem tartalmazza, külön kell biztosítani.

Vigyázzon a biztonságára.

1. A kerti házat száraz helyen és jó időjárási körülmények között szerelje össze.
2. A ház összeszereléséhez 2-4 emberre van szükség.
3. Az összeszerelés során használjon védőruházatot, kesztyűt és védőszemüveget.
4. Az összeszereléskor gyermekek és háziállatok nem tartózkodhatnak a helyszínen.

Kezelés és karbantartás

1. A kerti ház ajtaját tartsa zárva, hogy elkerülje a szél okozta károkat.
2. A ház tisztításához használjon rongyot és vizet.
3. Mindig söpörje le a tetőről a ráhullott leveleket a lehető leghamarabb, hogy elkerülje a tető elszíneződését. Rendszeresen távolítsa el a ráhulló havat. A tetőre hullott nagyobb hó károsíthatja a kerti házat.
4. A ház nem alkalmas lakásnak, csak kellékek tárolására. Ne tároljon benne forró tárgyakat, mint pl. forró grill, gázégő, illékony vegyi anyagok stb.

A magyar használati utasítás a gyártótól kapott verzió pontos fordítása.

A kézikönyvben használt fényképek csak illusztrációk, nem egyeznek meg pontosan a termékkel.



Dziękujemy za zakup naszego produktu.

Przed użyciem prosimy starannie przeczytać tę instrukcję.

Instrukcja montażu:

Przed przystąpieniem do montażu należy dokładnie zapoznać się z wszystkimi zaleceniami i informacjami.

Sprawdź, czy posiadasz wszystkie niezbędne elementy do zbudowania altany ogrodowej.

Altana musi być prawidłowo zakotwiona do płyty fundamentowej, aby przy mocno wiejącym wietrze nie doszło do jej uszkodzenia lub zniszczenia. Płyta fundamentowa nie jest elementem zestawu, należy ją wykonać we własnym zakresie.

Dbaj o swoje bezpieczeństwo.

1. Montaż altany ogrodowej przeprowadzić w miejscu suchym i przy sprzyjających warunkach pogodowych.
2. Montaż altany ogrodowej przeprowadzać przy udziale 2-4 osób.
3. Przy montażu należy użyć odzieży ochronnej, rękawic i okularów ochronnych.
4. Podczas trwania montażu na placu budowy nie powinny przebywać dzieci i zwierzęta domowe.

Pielęgnacja i konserwacja:

1. Drzwi altany ogrodowej pozostawiać w stanie zamkniętym i zabezpieczonym zamkniętym zamkiem, aby uniknąć uszkodzeń spowodowanych na skutek działania wiatru.
2. Altanę ogrodową czyścić używając ścierek i wody.
3. Zawsze, jak najprędzej, należy usuwać opadłe liście z dachu, aby nie powodowały wystąpienia przebarwień na dachu. Z dachu należy regularnie usuwać śnieg. Grubsza warstwa okrywy śniegowej może spowodować uszkodzenie dachu.
4. Altana ogrodowa nie jest przeznaczona do zamieszkania, służy do przechowywania rzeczy. W altanie ogrodowej nie składować przedmiotów gorących, jak np. rozpalony grill, lampy do opalania, lotne chemikalia, itp.

Polska wersja językowa instrukcji jest dokładnym tłumaczeniem oryginalnej instrukcji producenta. Zdjęcia wykorzystane w tym podręczniku są jedynie ilustracją i nie może dokładnie dopasować produkt.

Installation

Montage

Montáž

Összeszerelés

Montaż



Tools you will need / Werkzeuge, die Sie brauchen / Nástroje, které budete potřebovat
 Nástroje, ktoré budete potrebovať / Szükséges eszközök és szerszámok / Przyrządy
 i narzędzia, które będą potrzebne

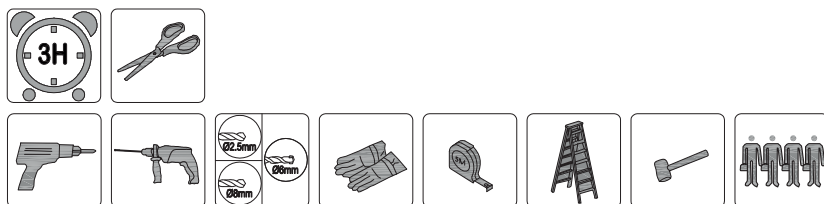



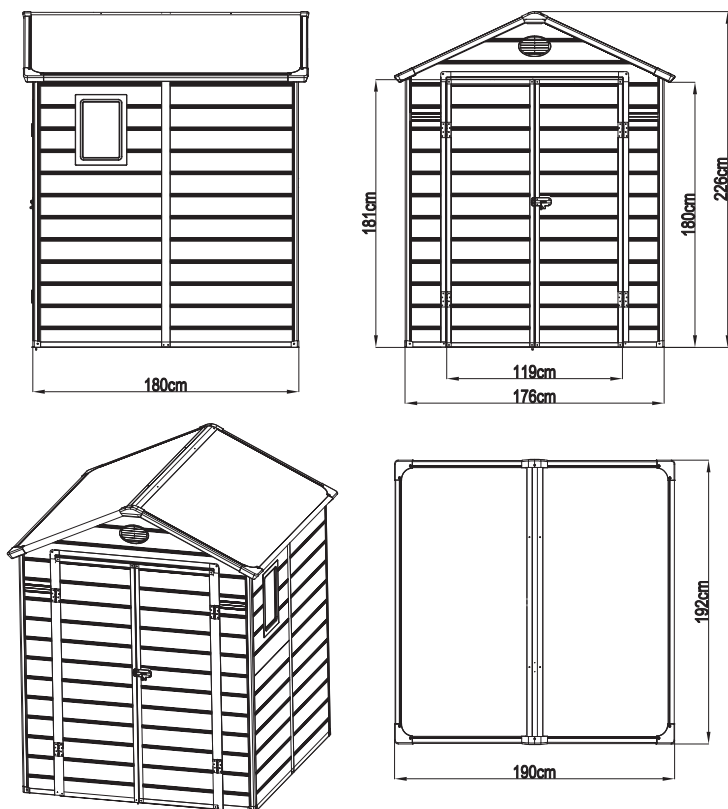



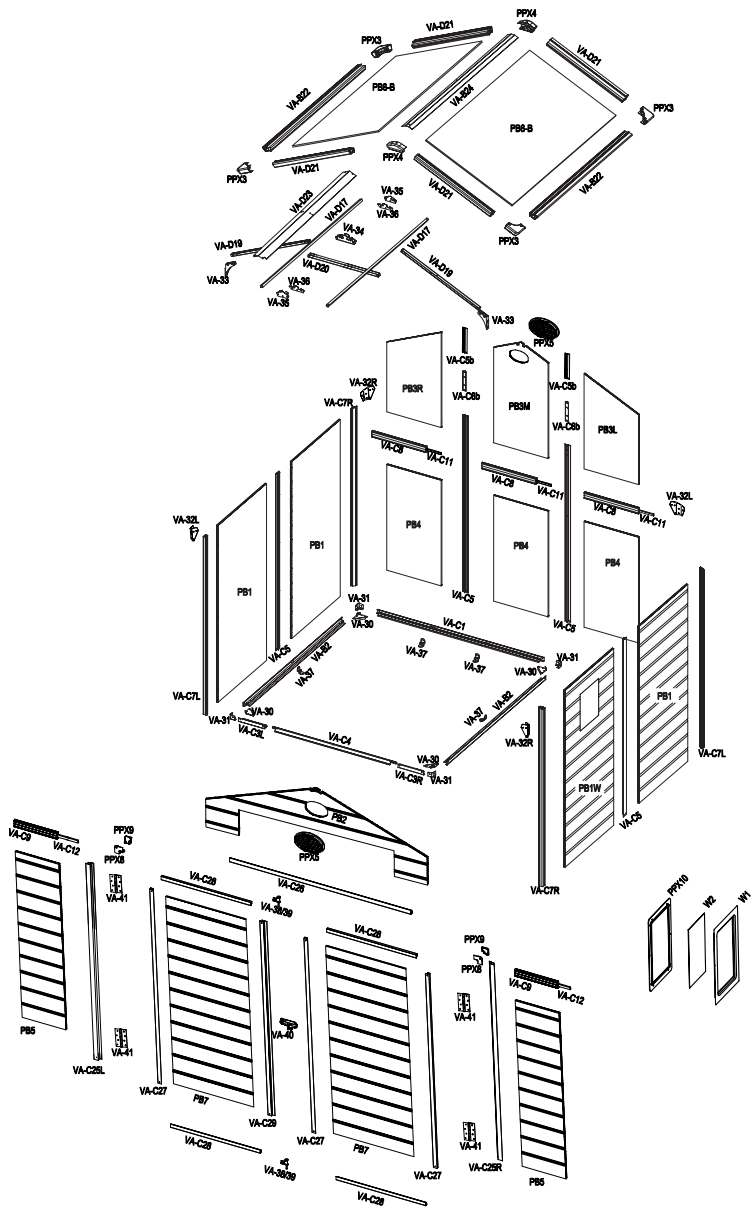

Dimensions \ Abmessungen \ Rozměry \ Rozmery \ Méretek \ Wymiary



VA-C1		1735mm	x1	1/2
VA-B2		1780mm	x2	1/2
VA-C3R		267mm	x1	1/2
VA-C3L		267mm	x1	1/2
VA-C4		1278mm	x1	1/2
VA-30			x4	2/2
VA-31			x4	2/2
VA-37			x4	2/2
PB1		876x1840mm	x3	1/2
PB1W		876x1840mm	x1	1/2
PB2		1710x676mm	x1	1/2
PB3L		566x990mm	x1	2/2
PB3R		566x990mm	x1	2/2
PB3M		566x1125mm	x1	1/2
PB4		566x1100mm	x3	2/2
PB5		255x1548mm	x2	1/2
VA-C7R		1860mm	x2	1/2
VA-C7L		1860mm	x2	1/2
VA-C5		1840mm	x4	1/2
VA-C5b		285mm	x2	1/2
VA-C6b		200mm	x2	1/2
W1			x1	1/2
W2			x1	1/2
PPX10			x1	1/2
VA-C8		562mm	x3	2/2
VA-C9		250mm	x2	2/2
VA-C11		562mm	x3	1/2
VA-C12		250mm	x2	1/2
VA-D17		1797mm	x2	1/2
VA-D19		888mm	x2	1/2
VA-D20		725mm	x1	1/2
VA-33			x2	2/2
VA-34			x1	2/2
VA-D23		1797mm	x1	1/2
VA-36			x2	2/2
VA-32R			x2	2/2
VA-32L			x2	2/2
VA-35			x2	2/2
PPX5			x2	2/2
PPX8			x2	2/2
PPX9			x2	2/2

PB6-B		990x1865mm	x2	1/2
VA-D21		870mm	x4	2/2
VA-B22		1705mm	x2	1/2
VA-B24		1900mm	x1	1/2
PPX3			x4	2/2
PPX4			x2	2/2
VA-C25R		1830mm	x1	1/2
VA-C25L		1830mm	x1	1/2
VA-C26		1198mm	x1	1/2
VA-C27		1812mm	x3	1/2
VA-C28		592mm	x4	1/2
VA-C29		1812mm	x1	1/2
PB7		591x1810mm	x2	1/2
VA-41			x4	2/2
VA-38a			x2	2/2
VA-38b			x2	2/2
VA-39			x2	2/2
VA-40			x1	2/2
CN-A33			x2	2/2
PA01			x3	2/2
VA-D44		ST4.2x13mm	x234	2/2
VA-D45		ST4.2x19mm	x103	2/2
VA-D46		ST4.2x13mm	x8	2/2
VA-D47		ST4.2x19mm	x4	2/2
VA-D48		ST6.0x40mm	x13	2/2
VA-D49		ST4.2x13mm	x8	2/2
VA-D50		M6x40mm	x10	2/2
VA-51			x1	2/2



1	 VA-B2 [x2] 1780mm	 VA-C1 [x1] 1735mm	 VA-C3L [x1] 267mm	 VA-C3R [x1] 267mm	 VA-C4 [x1] 1278mm	 VA-30 [x4]	 VA-D44 [x20] 13mm	
----------	---	---	---	---	---	---	---	--

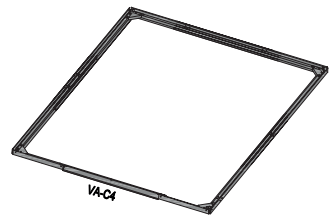
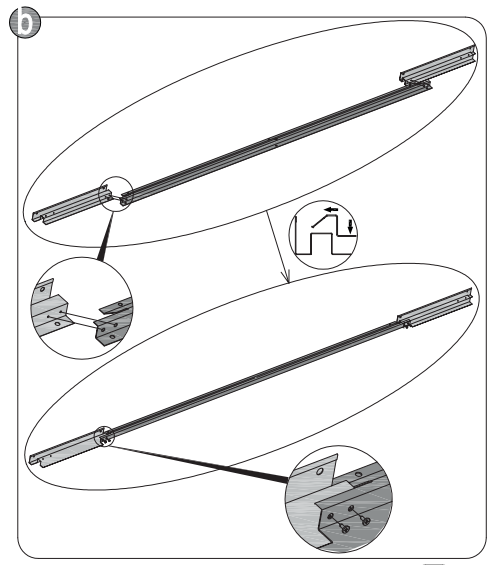
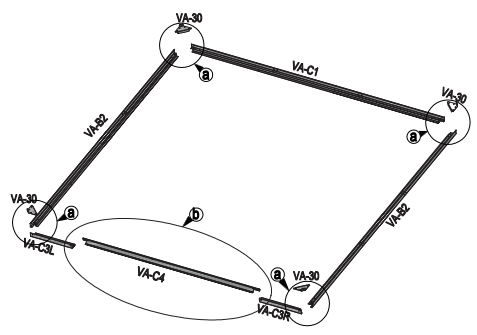
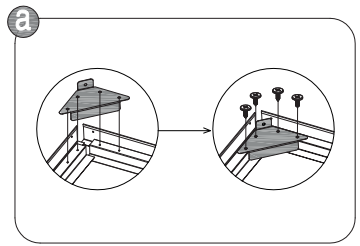



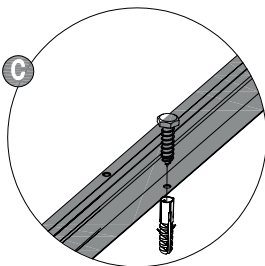
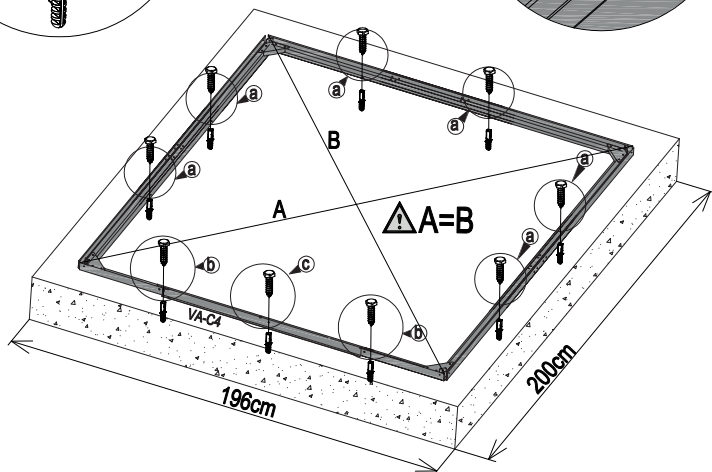
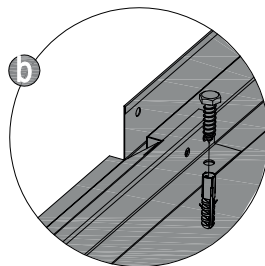
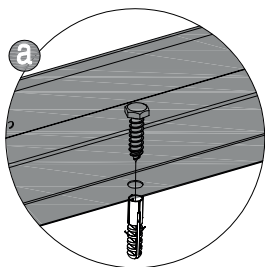

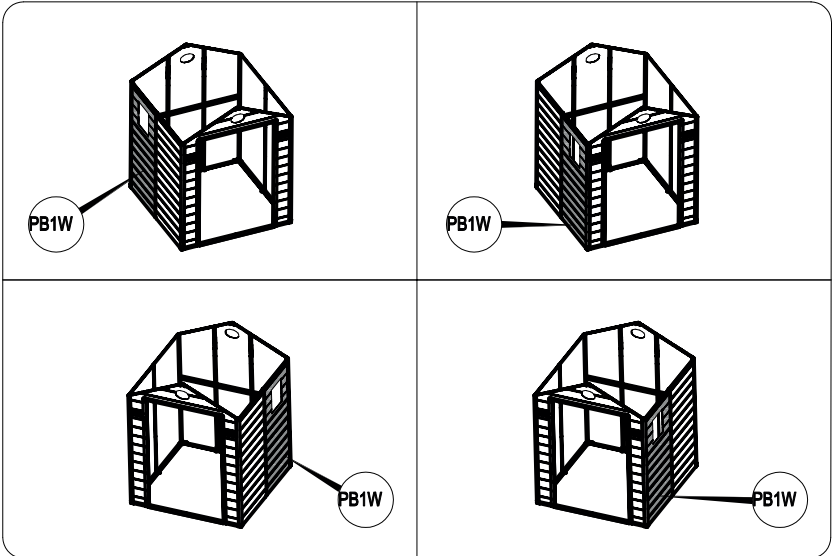
2	 VA-D48 [x9] 40mm
----------	--



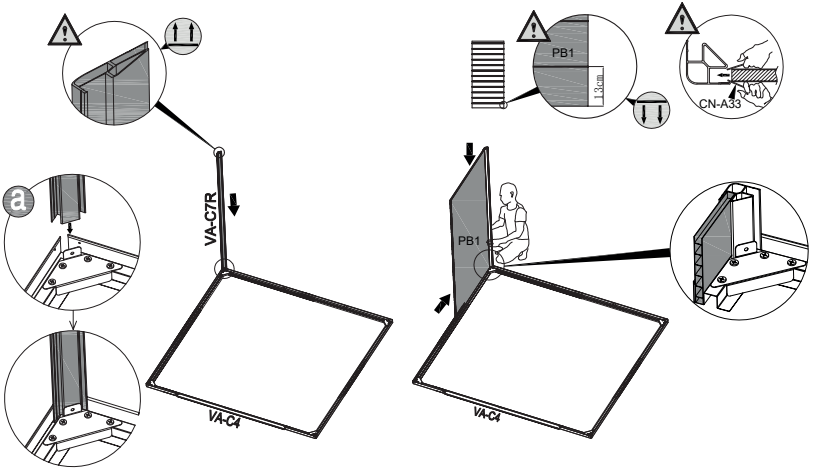





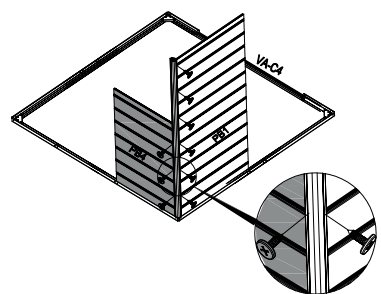
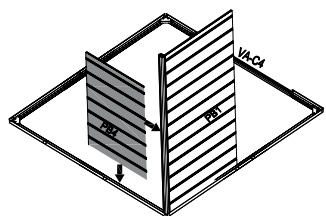

3	PB1 [x1] 876x1840mm	VA-C7R [x1] 1890mm	CN-A33	
----------	------------------------	-----------------------	--------	--





4	 PB4 [x1] 566x1100mm	 VA-D45 [x9] 19mm	 CN-A33	
----------	---	--	---	---



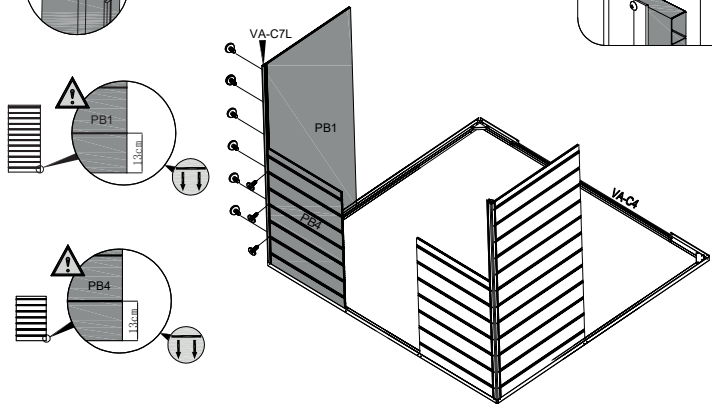



5	 VA-C7L [x1] 1860mm	 PB1 [x1] 876x1840mm	 PB4 [x1] 566x1100mm	 VA-D45 [x9] 19mm	 CN-A33	
----------	--	---	---	--	---	---

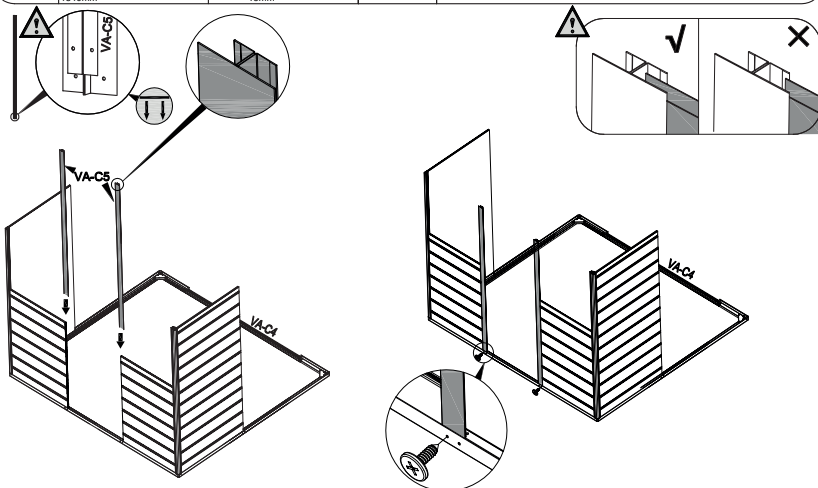





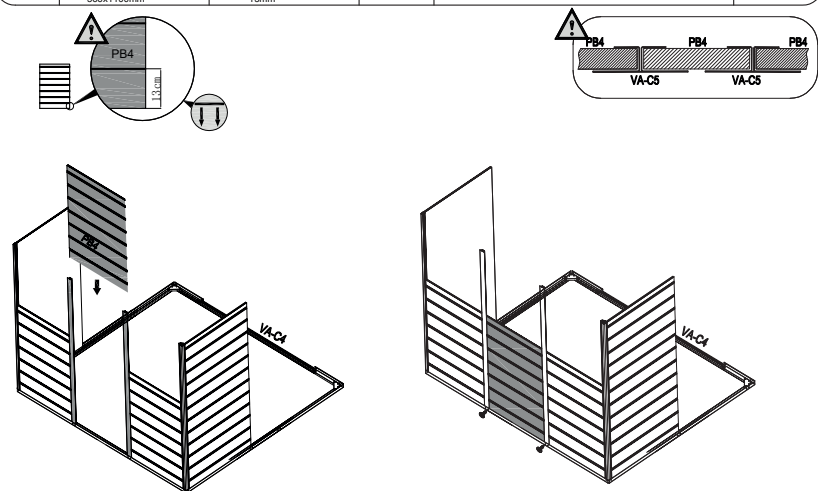

6	 VA-C5 [x2] 1840mm	 VA-D44 [x2] 13mm	 CN-A33	
----------	---	--	---	--

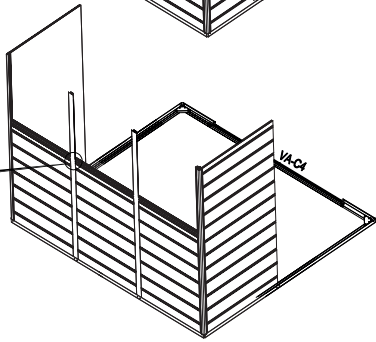
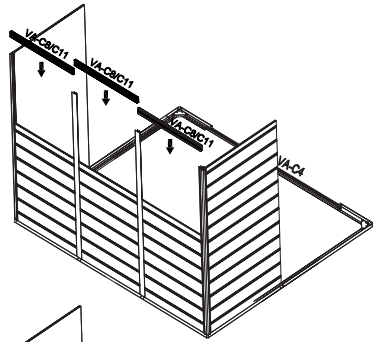
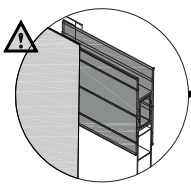
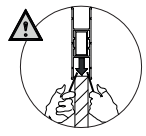
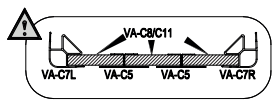
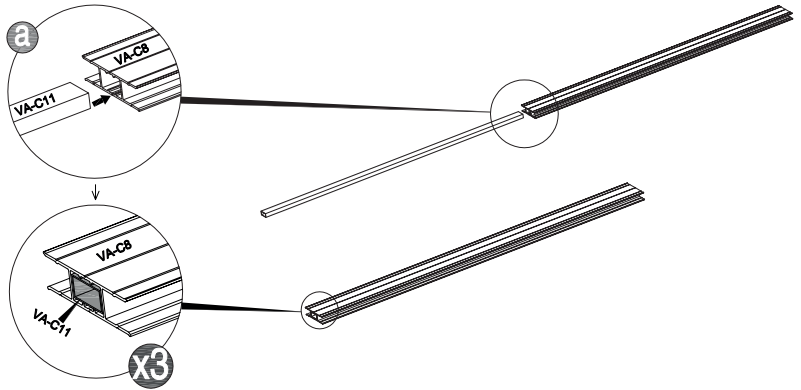







7	 PB4 [x1] 566x1100mm	 VA-D44 [x2] 13mm	 CN-A33	
----------	---	--	---	---

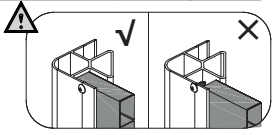
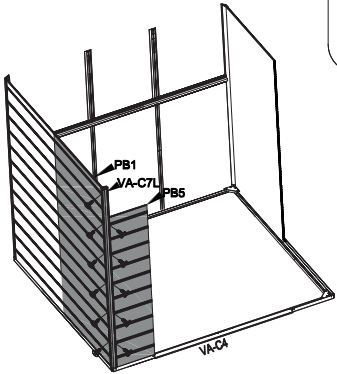
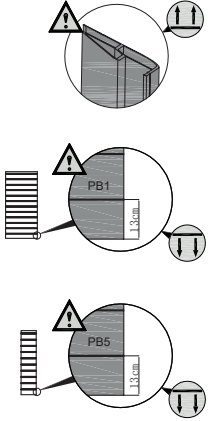



9						



10						

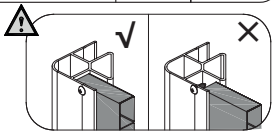
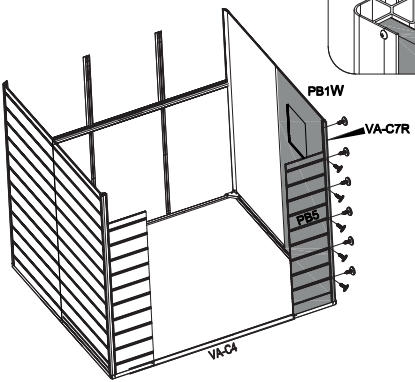
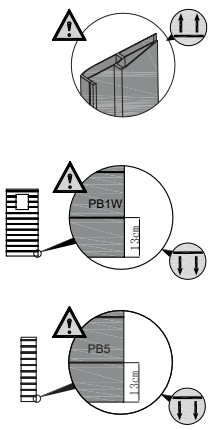

11



VA-31 [x4]



VA-D44 [x8]
13mm

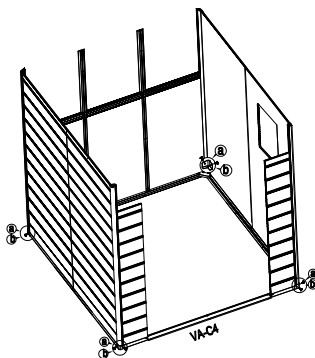
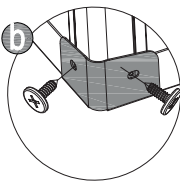
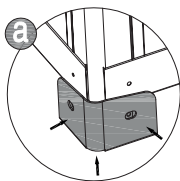



12



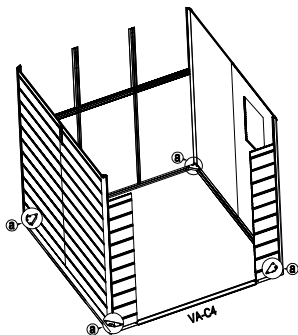
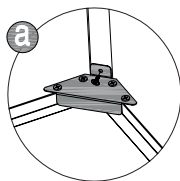



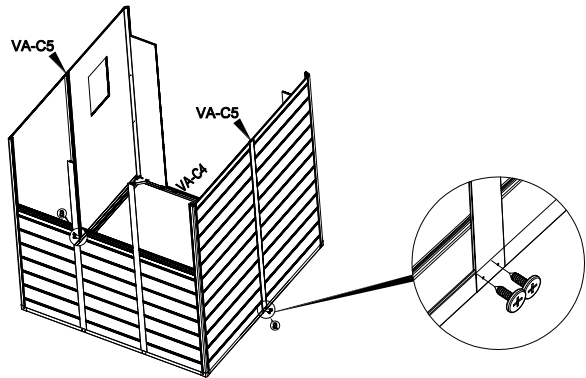
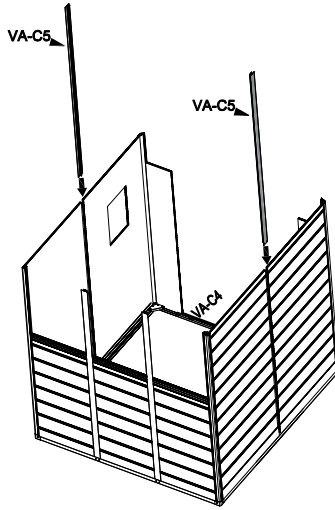
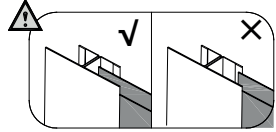
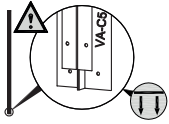

VA-D44 [x4]
13mm





13 VA-C5 [x2] 1840mm	 VA-D44 [x4] 1.3mm	 CN-A33	
-----------------------------------	---	---	--



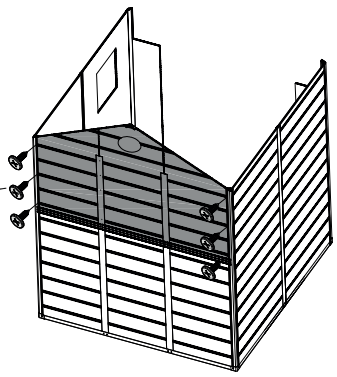
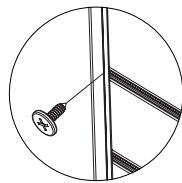
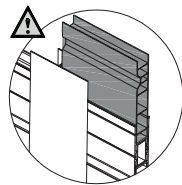
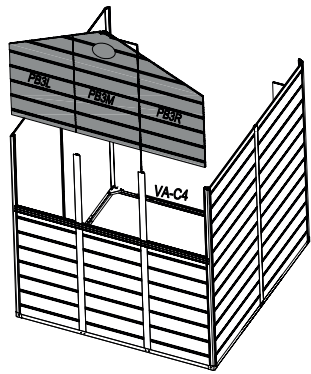
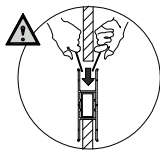
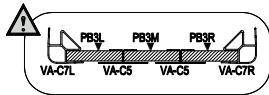

<p>14</p>	 <p>PB3L (x1) 566x990mm</p>	 <p>PB3R (x1) 566x990mm</p>	 <p>PB3M (x1) 566x1125mm</p>	 <p>VA-D45 (x6) 19mm</p>	 <p>CN-A33</p>	
------------------	--	--	---	---	---	---

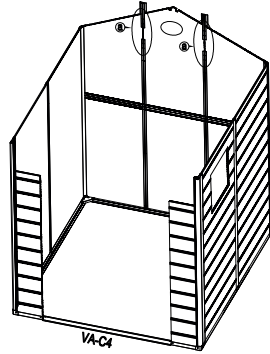
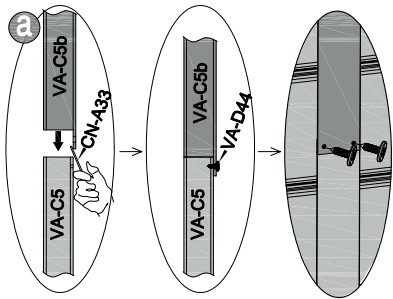
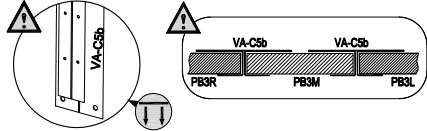

<p>15</p>	 <p>VA-C5b [x2] 285mm</p>	 <p>VA-D44 [x4] 13mm</p>	 <p>CN-A33</p>	
------------------	--	---	---	--





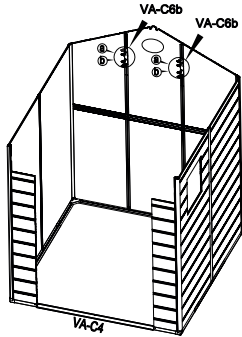
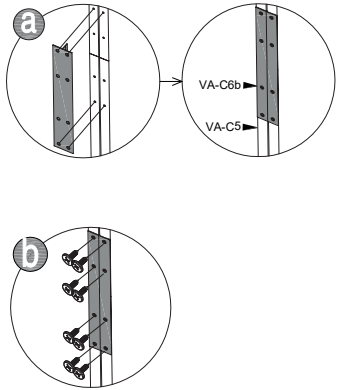

<p>16</p>	 <p>VA-C6b [x2] 200mm</p>	 <p>VA-D44 [x16] 13mm</p>	
------------------	--	--	--

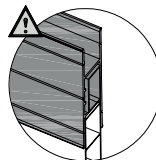
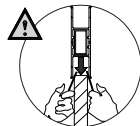
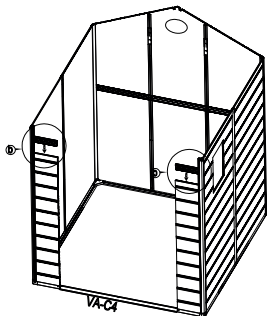
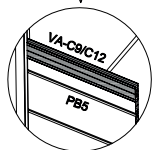
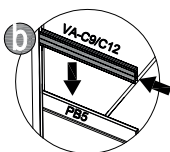
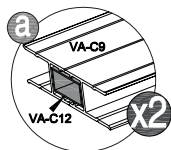



<p>17</p>	 <p>VA-C9 [x2] 250mm</p>	 <p>VA-C12 [x2] 250mm</p>		 <p>CN-A33</p>	
-----------	---	--	--	---	---



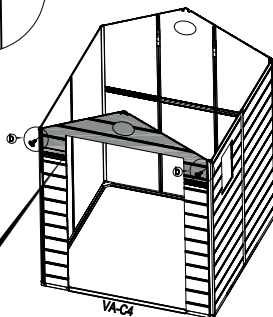
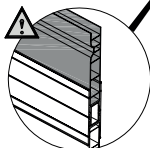
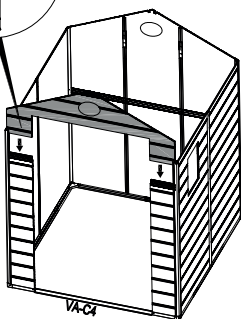
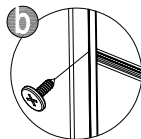



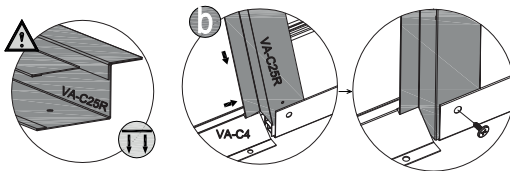
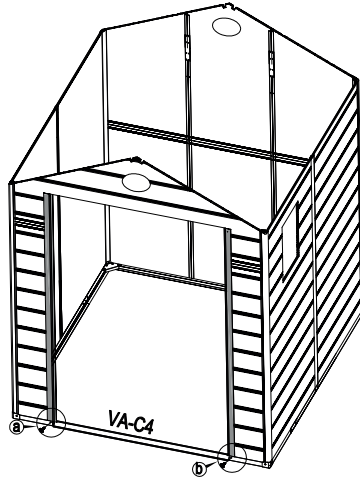
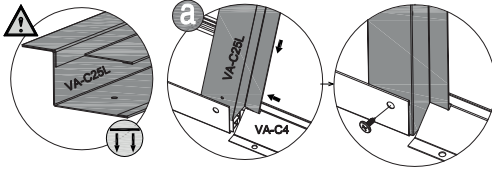

<p>18</p>	 <p>PB2 [x1] 1710x578mm</p>	 <p>VA-D45 [x2] 19mm</p>		 <p>CN-A33</p>		
-----------	--	---	--	---	---	---



19	 VA-C25L [x1] 1830mm	 VA-C25R [x1] 1830mm	 VA-D44 [x2] 13mm	
----	---	---	--	--





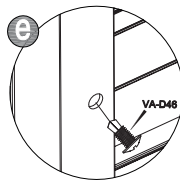
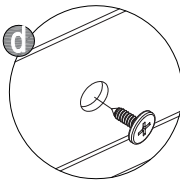
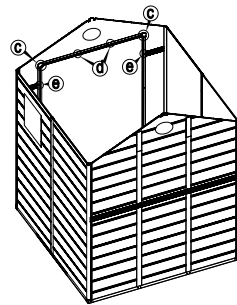
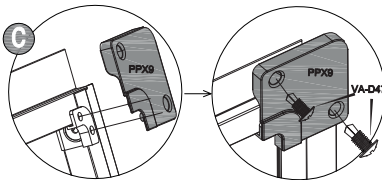
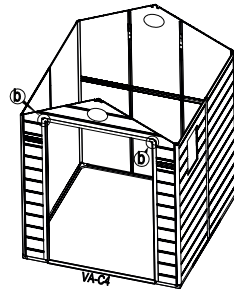
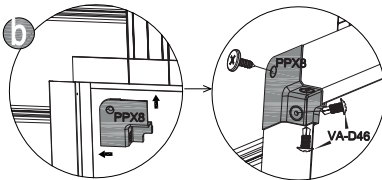
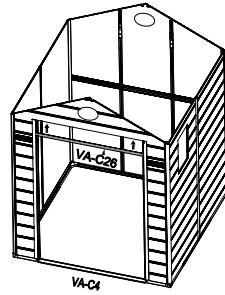
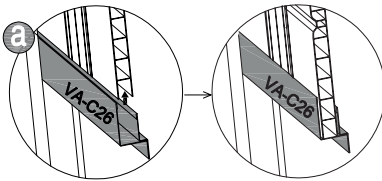

20	 VA-C26 [x1] 1198mm	 PPX8 [x2]	 PPX9 [x2]	 VA-D44 [x4] 13mm	 VA-D46 [x6] 13mm	 VA-D47 [x4] 19mm
-----------	--	--	--	--	--	--

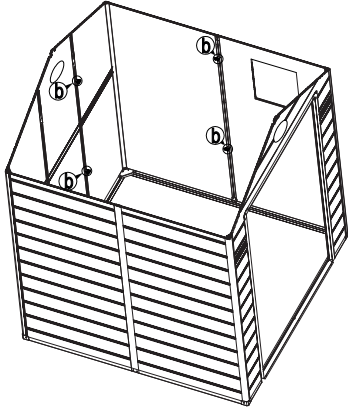
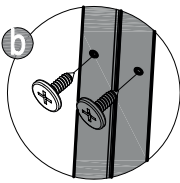
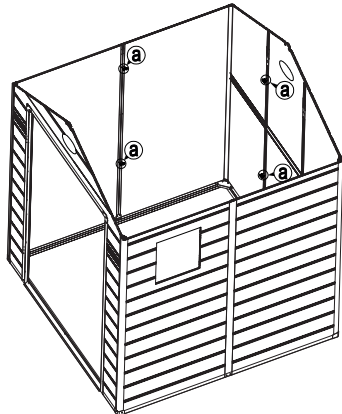
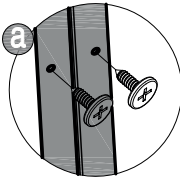

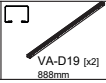
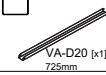

21

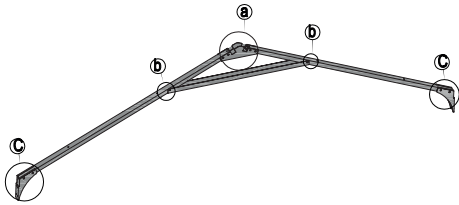
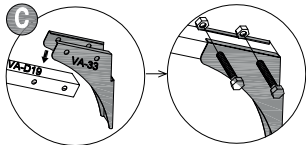
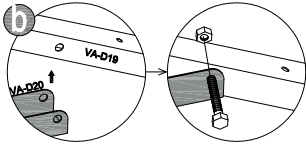
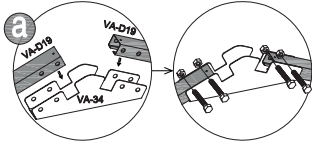

22	 VA-34 [x1]	 VA-33 [x2]	 VA-D19 [x2] 888mm	 VA-D20 [x1] 725mm	 VA-D50 [x10] 40mm	
-----------	---	---	---	---	---	--

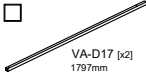

23	 VA-D17 [x2] 1797mm	 VA-D23 [x1] 1797mm	 VA-D44 [x4] 13mm	
-----------	--	--	--	--

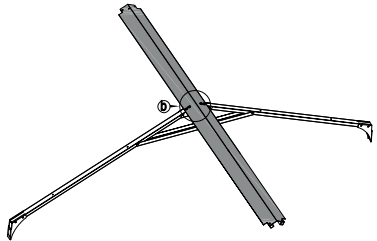
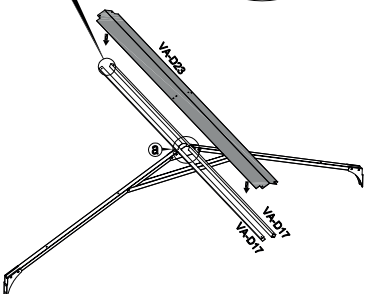
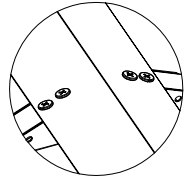
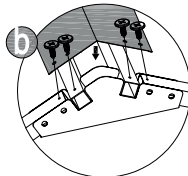
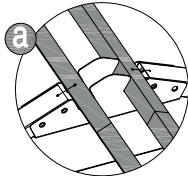
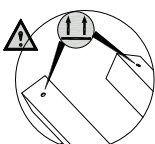

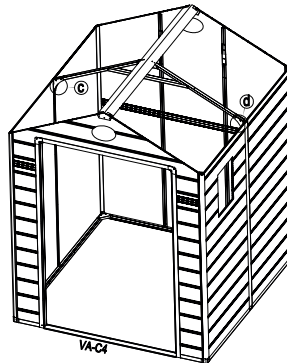
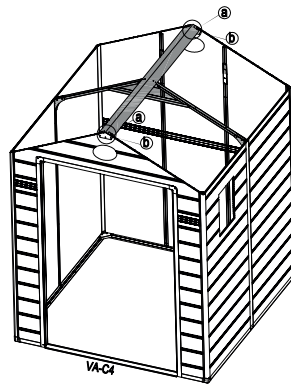
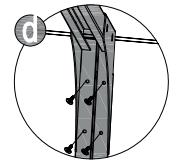
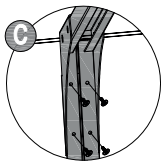
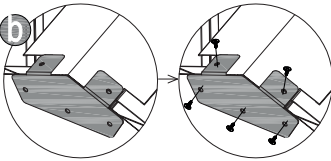
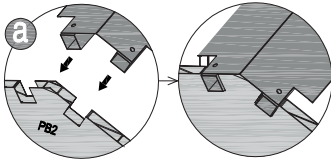

<p>24</p>	 <p>VA-35 [x2]</p>	 <p>VA-D44 [x18] 13mm</p>			
-----------	---	--	--	---	---

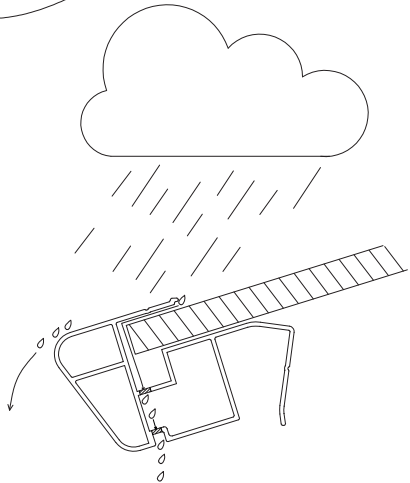
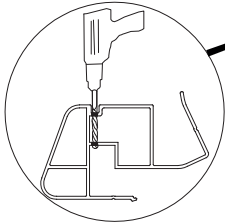
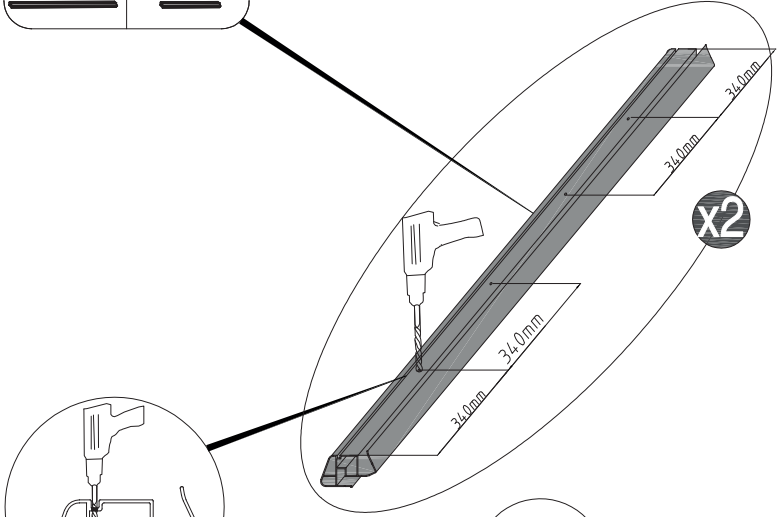
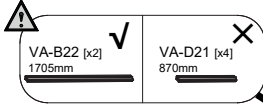

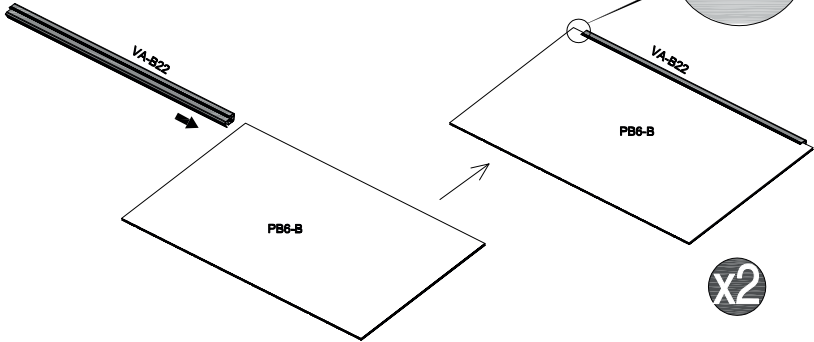
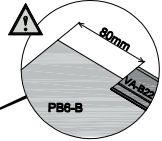
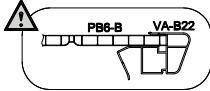

26	 PB6-B [x2] 990x1869mm	 VA-B22 [x2] 1705mm	 CN-A33	
----	---	--	---	--



27	 VA-D21 [x4] 870mm	 CN-A33	
----	---	---	--

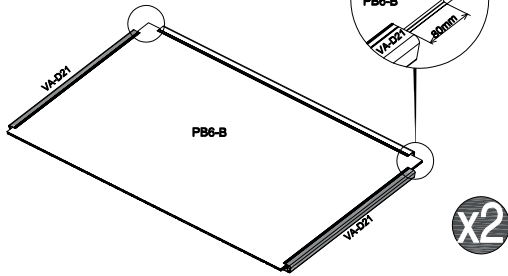
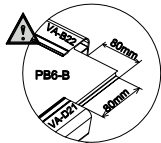
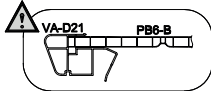

<p>28</p>	 <p>PPX3(x4)</p>	 <p>VA-D45 (x28) 19mm</p>	 <p>VA-D44 (x8) 13mm</p>		 <p>CN-A38</p>
-----------	---	--	---	--	---

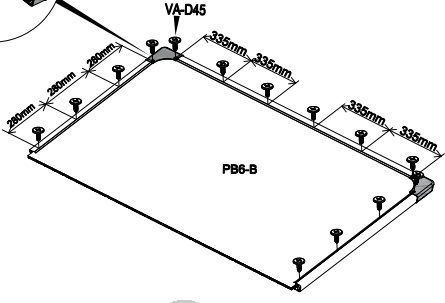
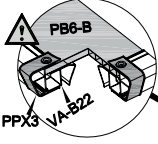
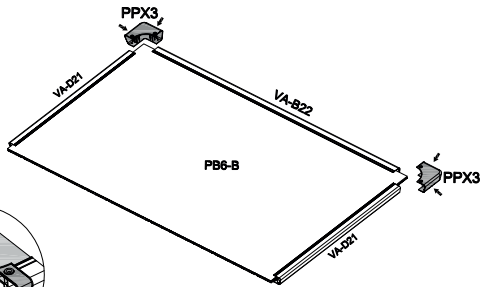
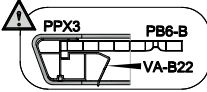

180°

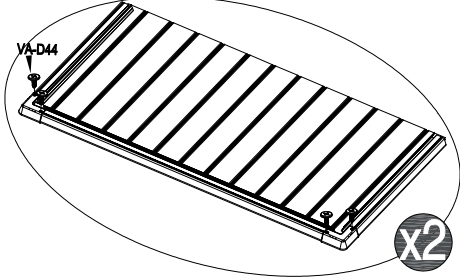

29



CN-A33

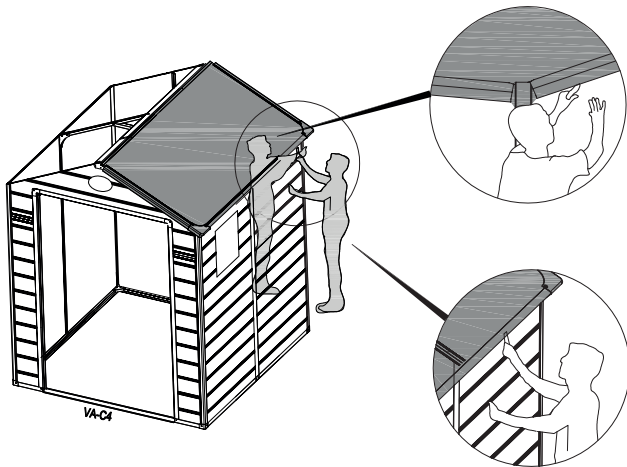
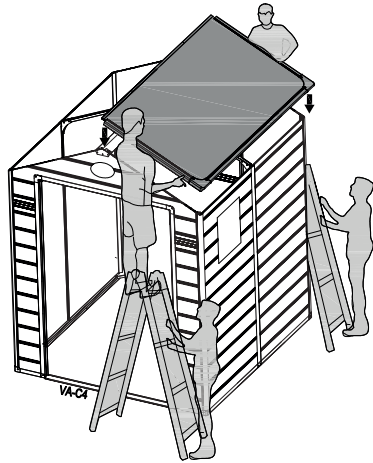
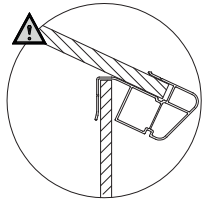
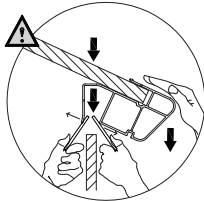

30



CN-A33

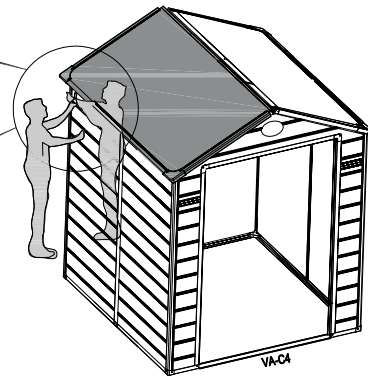
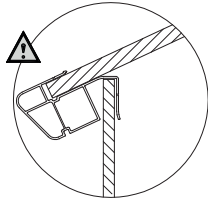
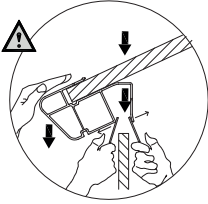

31

VA-D45 [x20]
19mm

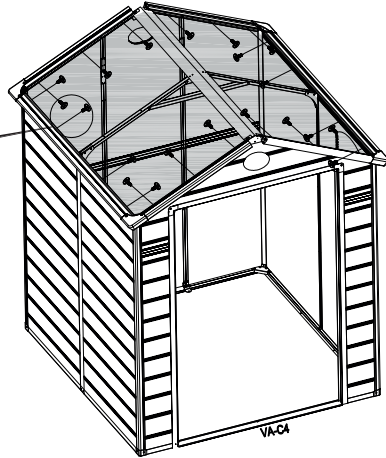
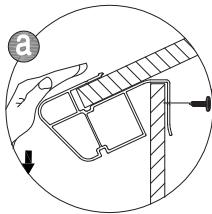

32

VA-B24 [x1]
1900mm

PPX4 [x2]

VA-D45 [x4]
19mm

VA-D44 [x4]
13mm

VA-D46 [x2]
13mm

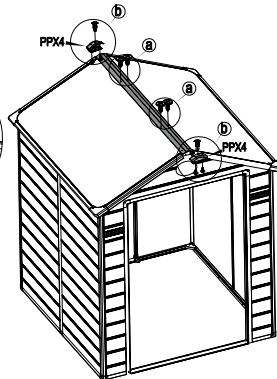
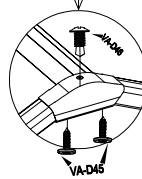
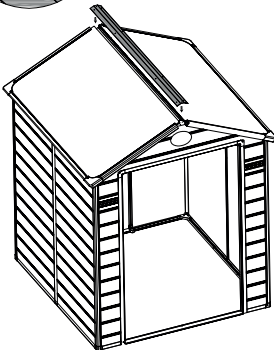
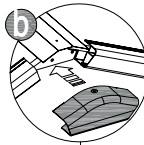
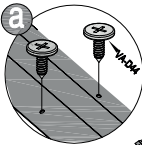





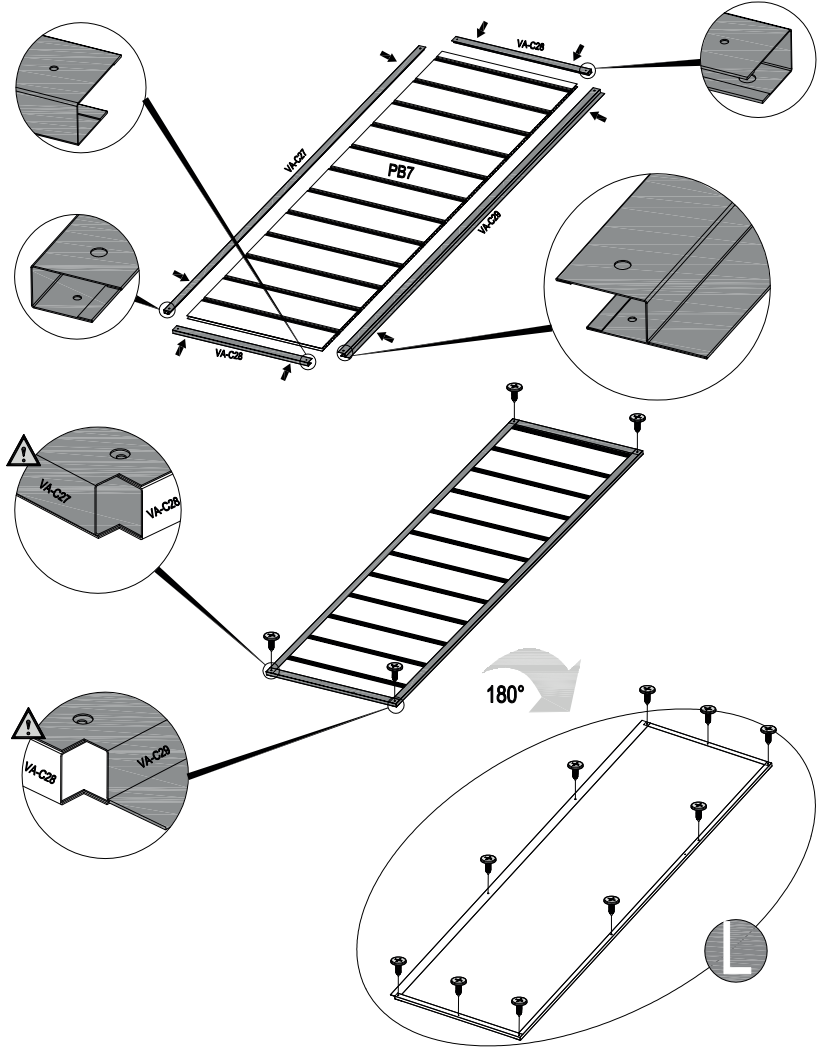

Door / Tür / Dveře / Dvere / Ajtók / Drzwi

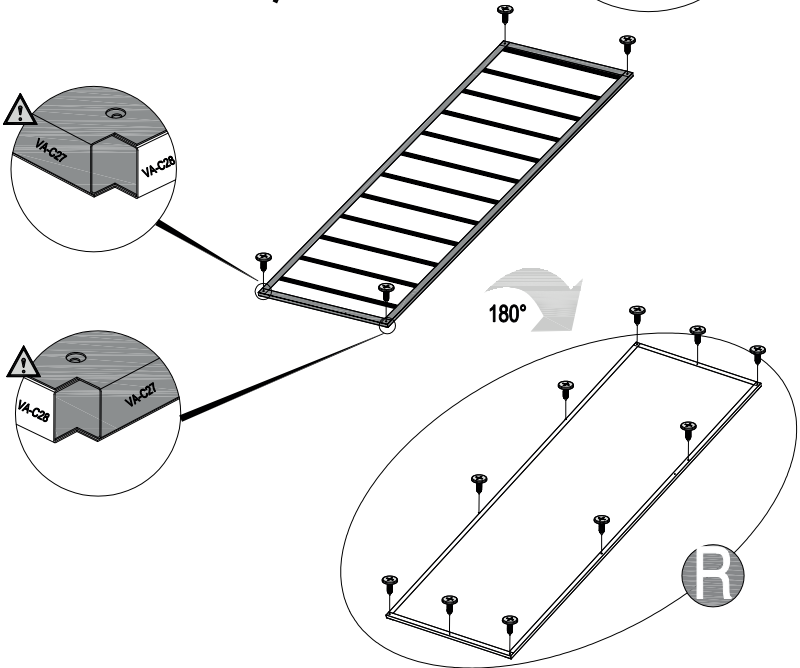
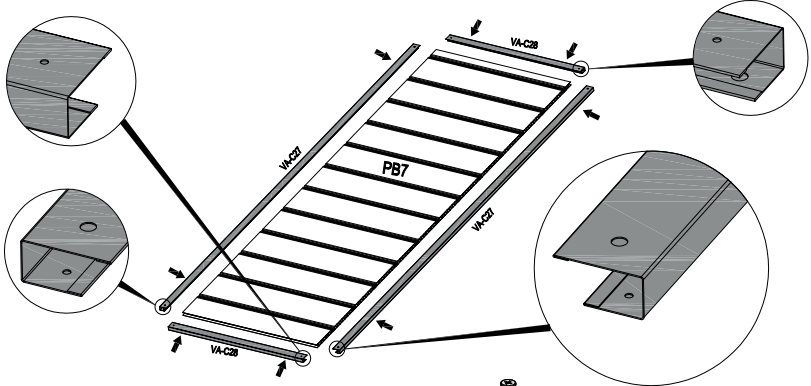
PB7 [x1] 591x1810mm	VA-C29 [x1] 1812mm	VA-C27 [x1] 1812mm	VA-C28 [x2] 592mm	VA-D44 [x14] 13mm			



34	PB7 [x1] 591x1810mm		VA-C27 [x2] 1812mm	VA-C28 [x2] 592mm	VA-D44 [x14] 13mm		
----	------------------------	--	-----------------------	----------------------	----------------------	--	--





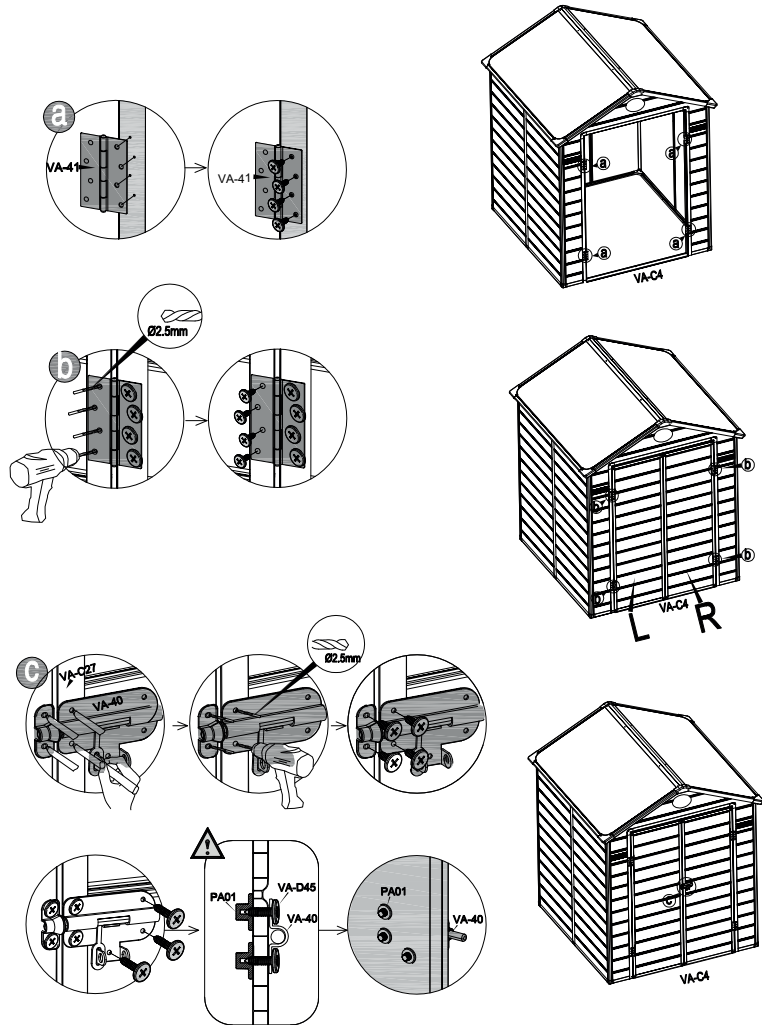

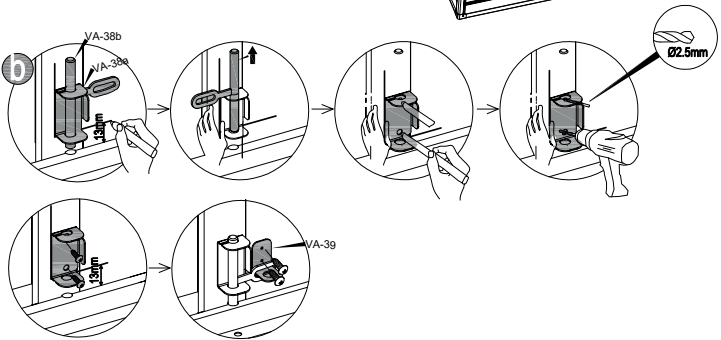
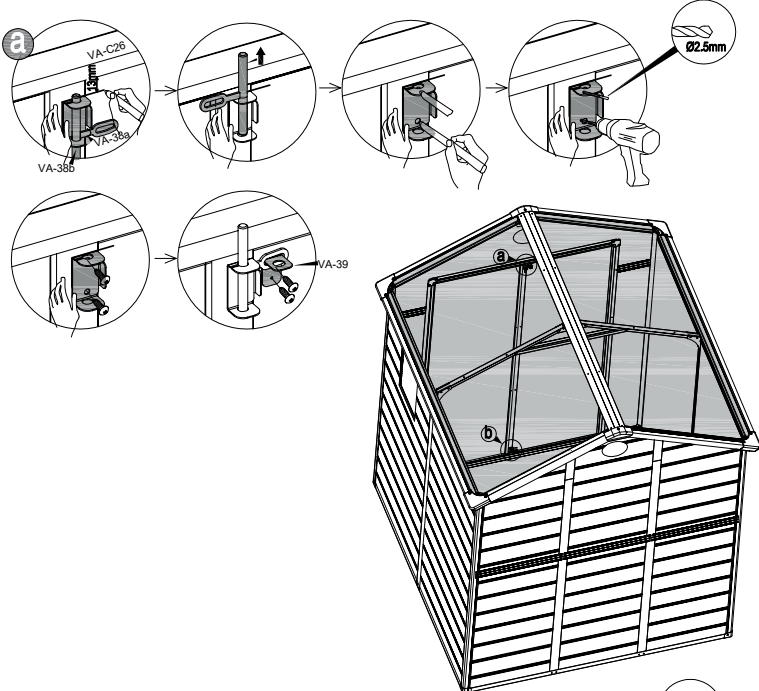

<p>35</p>	 <p>VA-41 [x4]</p>	 <p>VA-40 [x1]</p>	 <p>PA01 [x3]</p>	 <p>VA-D45 [x3] 19mm</p>	 <p>VA-D44 [x36] 13mm</p>	 <p>Ø2.5mm</p>
-----------	---	---	--	---	--	---



36	VA-38a [x2]	VA-38b [x2]	VA-39 [x2]	VA-D49 [x8] 13mm	Ø2.5mm	
-----------	-------------	-------------	------------	---------------------	--------	--



<p>37</p>	 <p>VA-36 [x2]</p>	 <p>VA-32L [x2]</p>	 <p>VA-32R [x2]</p>	 <p>VA-37 [x4]</p>	 <p>VA-D44 [x44] 13mm</p>	 <p>VA-D48 [x4]</p>
------------------	---	--	--	---	--	--

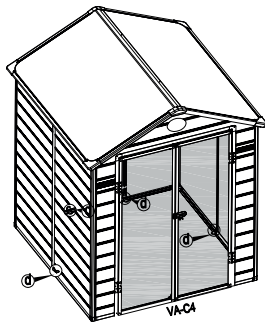
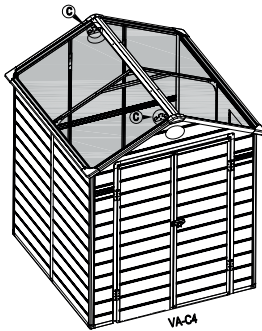
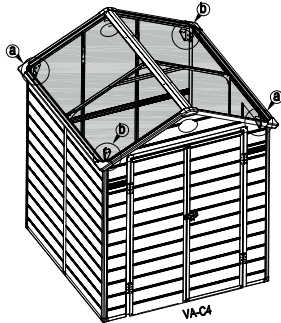
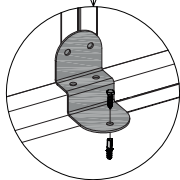
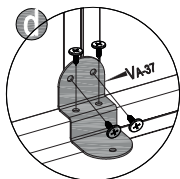
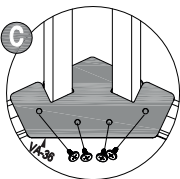
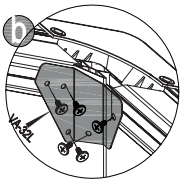
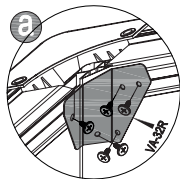

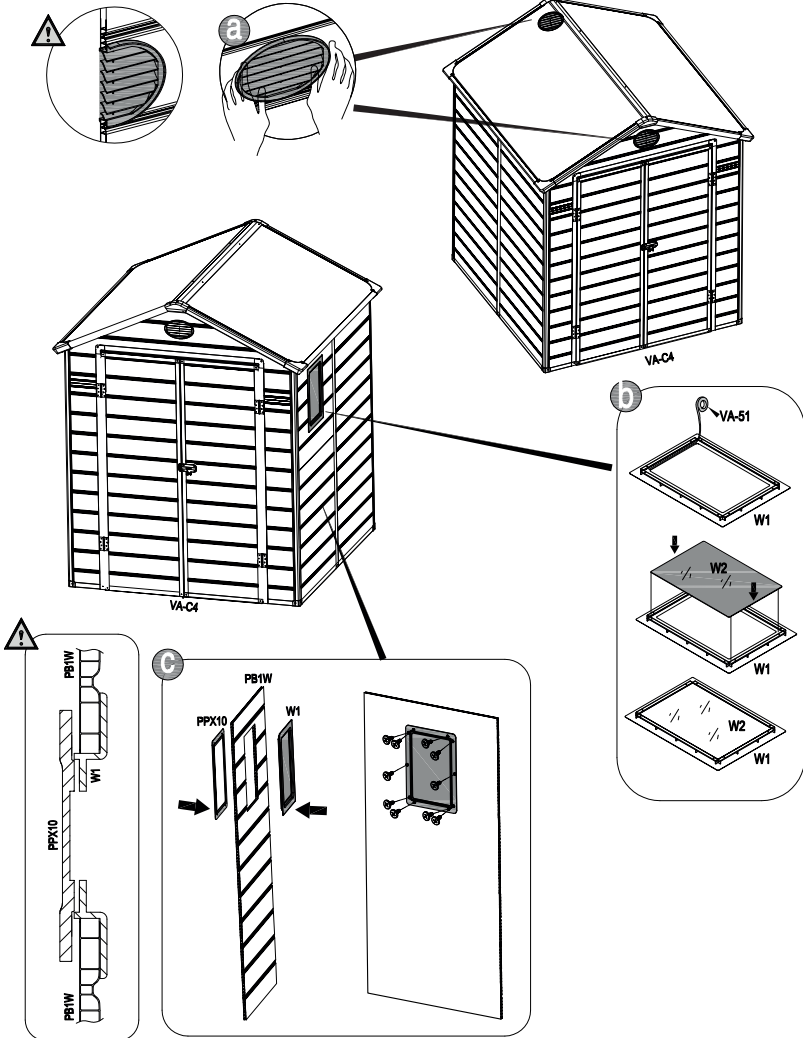
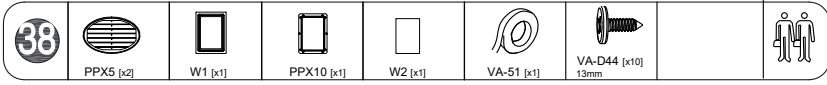

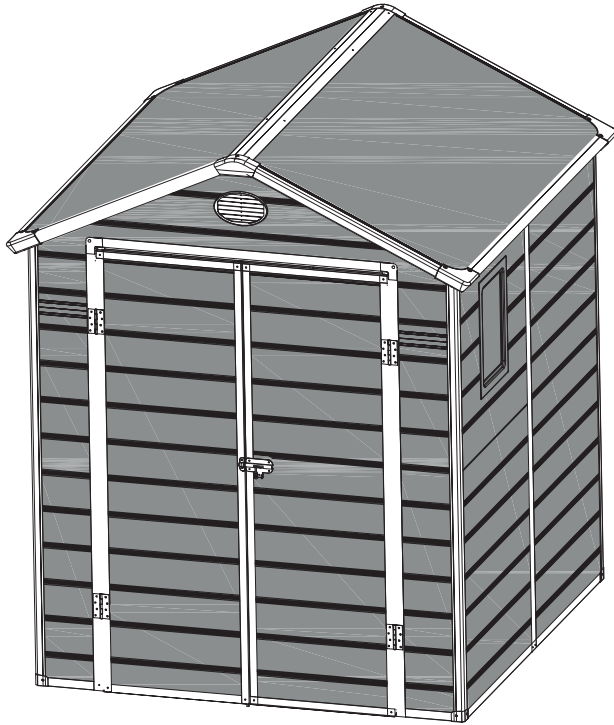

۲۷

